



Diamond Tooling Systems

CBN

Wendeschneidplatten | indexable inserts



Einsatzgebiete:	application range:
Gehärteter Stahl 42 - 72 HRC	hardened steel 42 - 72 HRC
Werkzeugstahl	tool steel
Pulverstahl	powder steel
Sinterstahl	sinter steel
Grauguss	grey cast iron
Super Alloys	super alloys



Mit Sitz in Kaiserslautern-Deutschland haben wir uns auf die Entwicklung, Herstellung und den Vertrieb von Präzisionswerkzeugen aus ultraharten Schneidstoffen wie CVD-D (CVD-Dickfilm Diamant), PKD (Polykristalliner Diamant) und CBN (Kubisches Bornitrid) spezialisiert und national so wie international erfolgreich am Markt etabliert.

Um diese ultraharten Schneidstoffe wie PKD, CBN und den CVD-Dickfilm Diamant auf Präzisionswerkzeugen wirtschaftlich bearbeiten zu können haben wir schon früh erkannt, dass wir uns von der alten Produktionstechnologie „Schleifen“ hin zu neuen Technologien wie der „Lasertechnologie“ weiterentwickeln müssen.

Ultraharte Hochleistungsschneidstoffe haben eine Schlüssel-funktion in der spanenden Fertigung.

Präzisionswerkzeuge aus ultraharten Schneidstoffen sind sehr erklärungsbedürftige Produkte. Der wirtschaftliche Einsatz der Schneidstoffe ist nur sichergestellt, wenn der Zerspanungsprozess und der Schneidstoff aufeinander abgestimmt sind.

Genau hier setzt Diamond Tooling Systems GmbH an, „Unsere Kernkompetenz sind Präzisionswerkzeuge aus ultraharten Schneidstoffen“. Diese Hightech-Werkzeuge müssen zum Zerspanungsprozess mit Anwendungstechnikern genau abgestimmt werden, nur so ist es möglich, das optimale Potenzial auszuschöpfen.

Mit mehr als 25 Jahren Optimierungserfahrung in der verarbeitenden Industrie sehen wir hier unsere Stärke! Während der laufenden Produktion stehen wir Ihnen mit unseren erfahrenen Anwendungstechnikern beratend zur Seite. Diese enge Zusammenarbeit und das gegenseitige Vertrauen ist die Basis unseres Erfolges.



Located in Kaiserslautern, Germany we are specialized in the development, production and sales of precision tools made from ultra-hard cutting materials such as CVD-D (CVD, thick film diamond), PCD (polycrystalline diamond) and CBN (cubic boron nitride). We have successfully established these in national and international markets.

In order to economically process these ultra-hard cutting materials such as PCD, CBN and CVD thick film diamond onto precision tools we noticed at an early stage that we should move on from the older manufacturing technologies such as grinding and advance to newer technologies such as laser technology.

Ultra-hard high-performance cutting materials now have a key function and place in the metal cutting industry and production. Precision tools from ultra-hard cutting materials are products which require a more depth of explanation. The economical usage of these materials provides a guarantee when the cutting process and cutting materials are fully aligned. This is where "Diamond Tooling Systems GmbH" comes into the picture. We provide these precision tools made from such ultra-hard cutting materials.

These high-tech tools require together with an experienced application engineer a need to be aligned with the cutting process in order to exploit their optimal potential. Our strengths lie in having more than 25 years of optimization experience within the producing industry. During the initial stages of running production, we will be by your side offering a professional consultation service along with our experienced application engineers. This side by side cooperation based on mutual trust is the keystone of our success.



Schneidstoffgruppen

groups of cuttingmaterial..... 5

ISO Nummernschlüssel

ISO codes 6

Wiper Geometrien

wiper geometries..... 7

Formeln

formulas..... 7

Schnittdaten Empfehlungen

recommended cutting parameters 8

CCGT | Z1 10

CCGW | Z2 10

CDGW | Z2 12

CNGA | Z2 12

CNGA | Z4 14

DCGT | Z1 14

DCGW | Z2 16

DXGW | Z1 16

DNGA | Z2 18

DNGA | Z4 18

EPGW | Z2 20

EPGW | FullFace 20

ODGW | FullFace Z8 20

RCGW | FullFace 21

RDHX | FullFace 21

RBGN | FullFace 22

SCGW | Z4 22

SNGA | Z4 22

RNGN | Solid 23

SNGA | Z8 24

SNGA | Solid Z8 24

TCGW | Z3 24

TNGA | Z3 26

TNGA | Z6 26

TPGW | Z1 26

VBGW | Z2 28

VCCT | Z1 28

VCGW | Z2 30

VXGW | Z1 30

VNGA | Z2 32

VNGA | Z4 32

WCGW | Z3 32

WNGA | Z3 34

WNGA | Z6 34

WNGA | Z3 SKL / CL = 6,5 mm 34

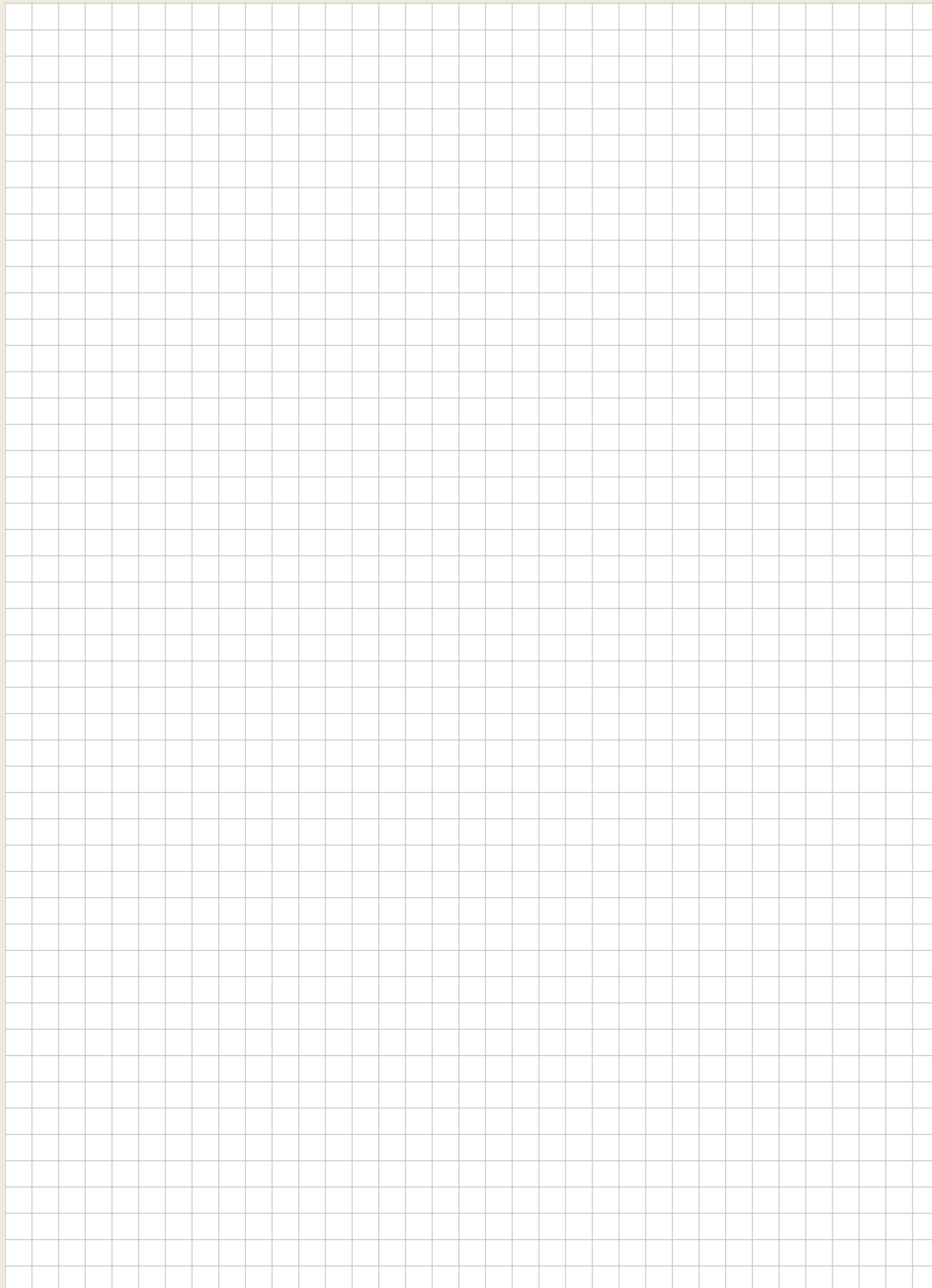

Härte | hardness (kg/mm²)

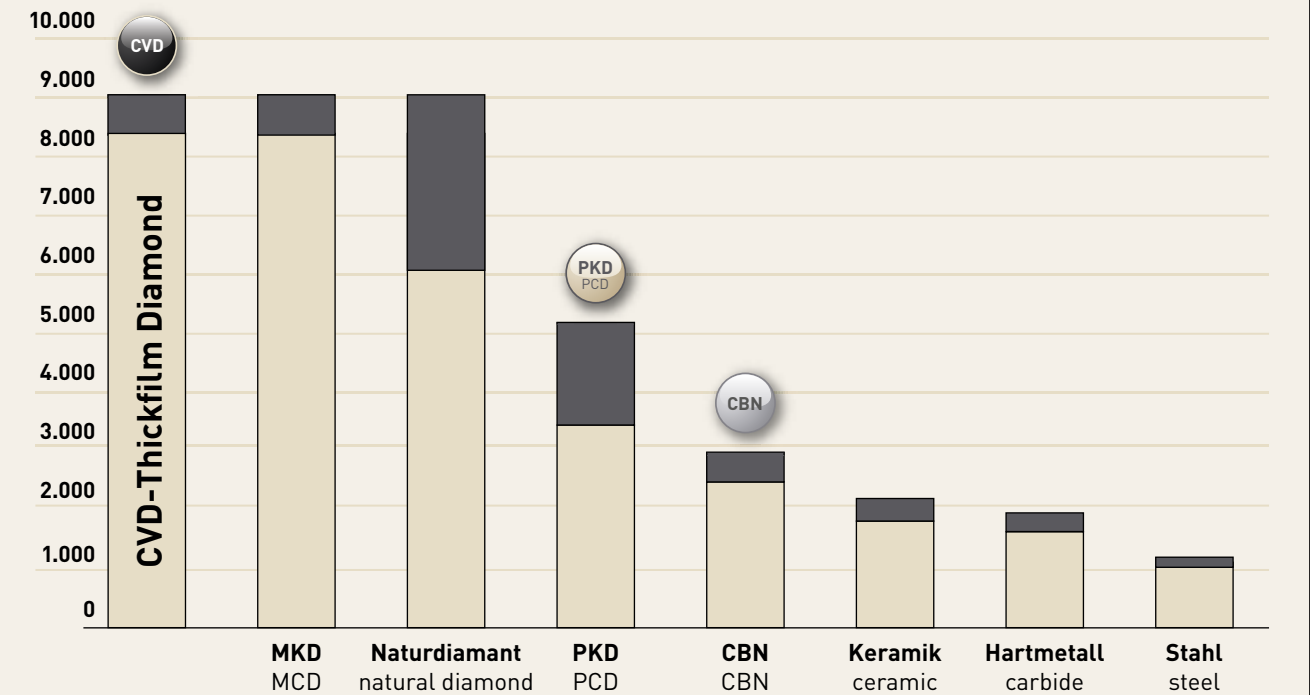

CBN – chemisch resistent und stabil bei hohen Temperaturen

Eigenschaften

In vielen Anwendungen wird das kubische Bornitrid dem Diamanten vorgezogen, da es an der Luft bei Temperaturen bis zu 1400° C stabil ist. Diamant beginnt sich bereits ab 800° C zu zersetzen. Eine weitere Eigenschaft gegenüber PKD ist die chemische Resistenz gegenüber eisenhaltigen Werkstoffen.

Einsatzgebiete

Hartbearbeitung, GG, GGG, Sintermetall, Super Alloys.

Herstellung

Bornitrid Pulver ist der Ausgangsstoff für die Herstellung von kubischem Bornitrid, das seit Ende der 60er Jahre erhältlich ist. Es wird unter hohem Druck und bei Temperaturen von über 1500° C hergestellt. Kubisches Bornitrid gilt heute nach Diamant als zweithärteste Substanz.

CBN - chemically resistant and stable at high temperatures

Characteristics

Cubic boron nitride is preferred over diamond in many applications, since it is stable at temperatures up to 1400° C in air. Diamond starts to decompose from 800° C. A further characteristic as compared to PCD is the chemical resistance to ferrous materials.

Areas of application

Hard machining, GG, GGG, sintered metal, super alloys.

Manufacture

Boron nitride powder is the source material for the manufacture of cubic boron nitride, which has been available since the late 60s. It is manufactured under high pressure and at temperatures of over 1500° C. Cubic boron nitride is now regarded as the second hardest substance after diamond.

Grundform | shape

T N G A 16 04 08

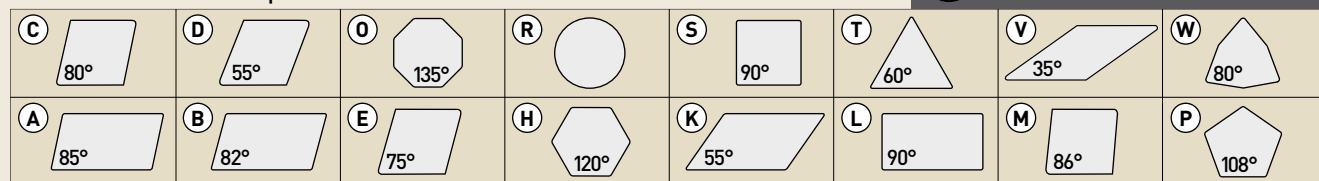

Freiwinkel | clearance

T N G A 16 04 08

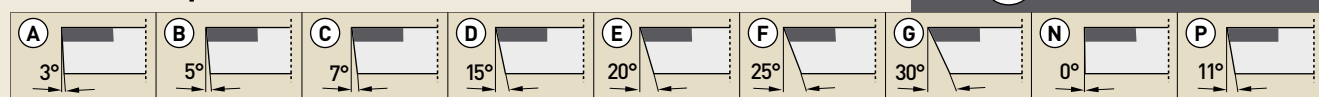

Toleranz (mm) | tolerance (mm)

T N G A 16 04 08

	m	s	d		m	s	d
A	±0,005	±0,025	±0,025	J	±0,005	±0,025	±0,05 → ±0,15
F	±0,005	±0,025	±0,013	K	±0,013	±0,025	±0,05 → ±0,15
C	±0,013	±0,025	±0,025	L	±0,025	±0,025	±0,05 → ±0,15
H	±0,013	±0,025	±0,013	M	±0,08 → ±0,20	±0,130	±0,05 → ±0,15
E	±0,025	±0,025	±0,025	N	±0,08 → ±0,20	±0,25	±0,05 → ±0,15
G	±0,025	±0,130	±0,025	U	±0,13 → ±0,38	±0,130	±0,08 → ±0,15

* (M, N, U) Die genaue Toleranz ist von der Größe der Platte abhängig | Die genaue Toleranz ist von der Größe der Platte abhängig

Plattentyp | insert type

T N G A 16 04 08

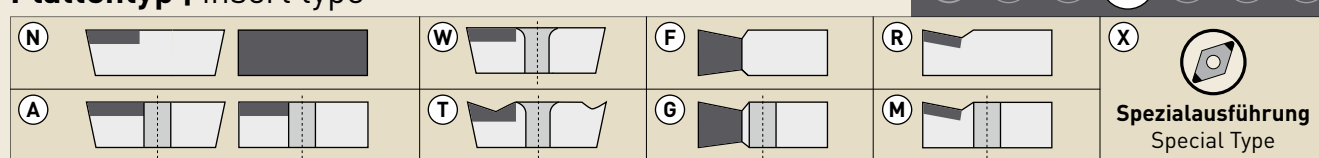

Plattengröße (mm) | insert size (mm)

T N G A 16 04 08

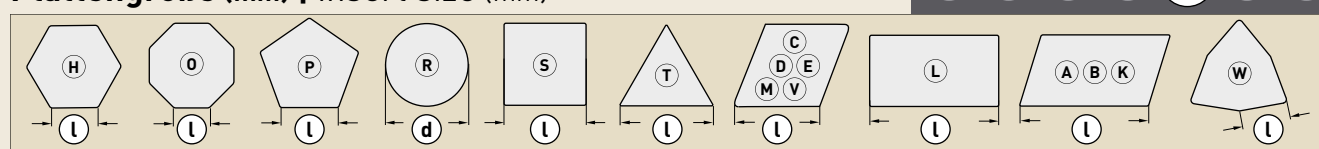

Dicke (mm) | insert size (mm)

T N G A 16 04 08

01	s = 1,59	T1	s = 1,98	02	s = 2,38	03	s = 3,18	T3	s = 3,97	04	s = 4,76	05	s = 5,56	06	s = 6,35
----	----------	----	----------	----	----------	----	----------	----	----------	----	----------	----	----------	----	----------

Bei Ziffern unter 10 wird eine Null vorgesetzt. Dezimalstellen bleiben unberücksichtigt. (Beispiel: 4,76 = 04)
By numbers below 10 a 0 is added in at the front. Decimals remain unconsidered (example: 4,76 = 04)

Schneidenecke (mm) | corner configuration (mm)

T N G A 16 04 08

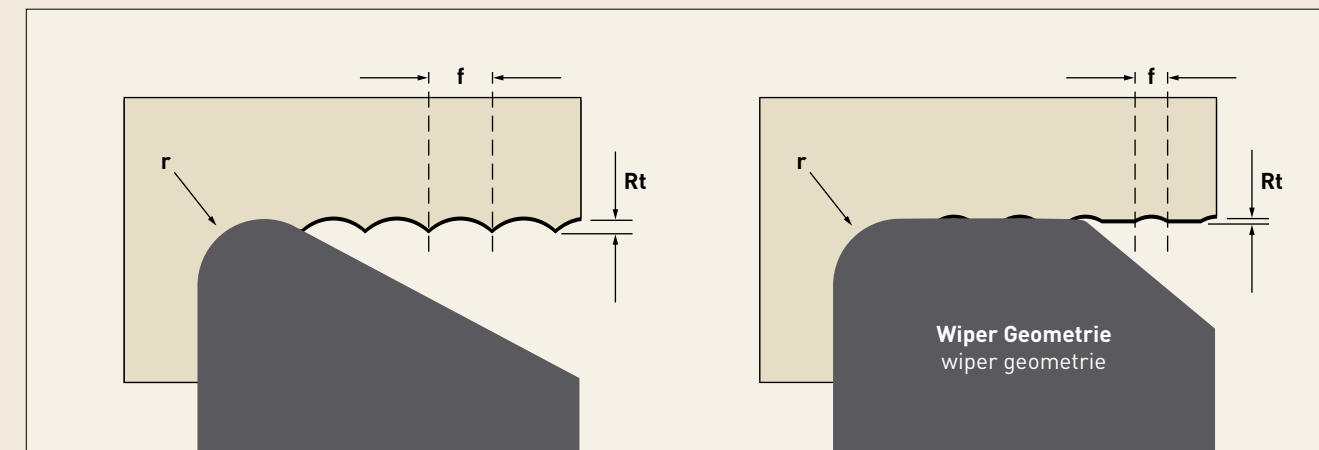
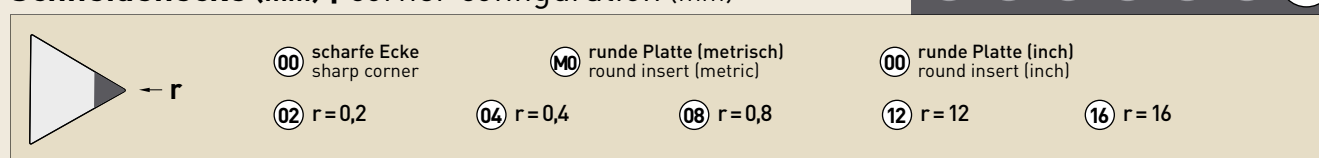

Vorteile beim Einsatz von Wiper Geometrien

Bei gleichem Vorschub kann eine 2 - 4fach bessere Oberflächen-güte erzielt werden oder bei 2 - 4fach höherem Vorschub kann die gleiche Oberflächengüte erzielt werden.

Um die Wiper-Schneide in den Schnitt zu bekommen bitte folgende Anstellwinkel an der Maschine beachten:

- C und W Type = 95°
- D Type = 93°
- T Type = 91°

Advantages when using wiper geometries

By using the same feed rate a 2 - 4 times better surface quality can be obtained or with a 2 - 4 times higher feed rate the same surface quality can be reached.

To get the wiper geometry into cutting condition please use following lead angles at the machine:

- C and W Type = 95°
- D Type = 93°
- T Type = 91°



Formeln | formulas

	metrisch metric		Zoll inch	
	Formel formula	Einheiten units	Formel formula	Einheiten units
Vorschubgeschwindigkeit feed rate	$V_f = f_n \times n$	mm/min	$V_f = f_n \times n$	Zoll/min inch/min
Spindeldrehzahl spindle speed	$n = \frac{V_c \times 1000}{\pi \times DC_{ap}}$	U/min rev/min	$n = \frac{V_c \times 12}{\pi \times DC_{ap}}$	U/min rev/min
Vorschub pro Umdrehung feed per revolution	$f_n = \frac{V_f}{n}$	mm/U mm/rev	$f_n = \frac{V_f}{n}$	Zoll/U inch/rev
Bearbeitungszeit cutting time	$T_c = \frac{l_m}{f_n \times n}$	min	$T_c = \frac{l_m}{f_n \times n}$	min
Zeitspanvolumen stock removal rate	$Q = V_c \times a_p \times f_n$	cm ³ /min	$Q = V_c \times a_p \times f_n \times 12$	Zoll ³ /min inch ³ /min

Schnittdaten Empfehlungen | recommended cutting parameters

Schnittdaten Empfehlungen | recommended cutting parameters

Schnittverhältnisse | cutting conditions



-  Glatter Schnitt
continuous cut
 -  Leicht unterbrochener Schnitt
light interrupted cut
 -  Unterbrochener Schnitt
interrupted cut
- Werkstoff | material

		beschichtet coated														
		H25			H45			H65			H85			H95		
		V _c [m/min]	a _p [mm]	F [mm/U]	V _c [m/min]	a _p [mm]	F [mm/U]	V _c [m/min]	a _p [mm]	F [mm/U]	V _c [m/min]	a _p [mm]	F [mm/U]	V _c [m/min]	a _p [mm]	F [mm/U]
		○			○ ◻ ◻			○ ◻ ◻			◻ ◻			○ ◻		
Gehärteter Stahl hardened steel bis / up to 72 HRC	min	100	0,01	0,01	100	0,01	0,01	100	0,01	0,01	60	0,01	0,01	100	0,01	0,01
	med	200	0,15	0,15	180	0,15	0,15	160	0,15	0,15	120	0,15	0,10	160	0,15	0,15
	max	300	1,50	0,50	260	1,00	0,30	240	1,00	1,00	180	0,30	0,25	220	0,50	0,30
Kugellager- und Federstahl ball bearing and spring steel ab / off 45 HRC	min	100	0,01	0,01	100	0,01	0,01				80	0,01	0,01	80	0,01	0,01
	med	200	0,15	0,12	200	0,20	0,12				140	0,10	0,08	180	0,10	0,10
	max	400	0,50	0,25	350	0,80	0,40				180	0,30	0,15	250	0,30	0,30
Niedriglegierte Werkzeugstähle low alloy tool steel bis / up to 68HRC	min	80	0,01	0,01	60	0,01	0,01	60	0,01	0,01	60	0,01	0,01	80	0,01	0,01
	med	180	0,20	0,12	160	0,15	0,12	160	0,10	0,15	150	0,10	0,10	140	0,10	0,10
	max	240	2,50	0,25	220	1,50	0,25	200	0,50	0,25	180	0,30	0,20	180	0,50	0,30
Hochlegierte Werkzeugstähle und PM-Stähle high alloy tool steel and pm steel bis / up to 72 HRC	min	60	0,01	0,01	60	0,01	0,01	60	0,01	0,01	50	0,02	0,01	50	0,01	0,01
	med	160	0,12	0,10	140	0,12	0,12	140	0,12	0,12	90	0,20	0,10	120	0,12	0,08
	max	220	0,60	0,20	200	0,60	0,25	200	0,60	0,25	140	0,25	0,18	160	0,50	0,15
Kalt- und Warmarbeitsstähle cold worked and hot forming tool steel bis / up to 64 HRC	min	80	0,01	0,01	80	0,01	0,01				60	0,01	0,01			
	med	160	0,15	0,10	150	0,12	0,12				120	0,10	0,08			
	max	220	0,50	0,20	210	0,40	0,25				140	0,20	0,15			
Hart- / Weichbearbeitung hard and soft machining	min	80	0,01	0,01	80	0,01	0,01	80	0,01	0,01						
	med	240	0,20	0,15	240	0,25	0,15	240	0,25	0,15						
	max	300	1,50	0,30	300	1,50	0,30	300	1,50	0,30						
Sinterstahl gehärtet sintered steel hardened	min	80	0,01	0,01	80	0,01	0,01									
	med	180	0,20	0,12	160	0,16	0,10									
	max	240	2,50	0,30	220	2,00	0,30									

Empfehlenswert ist ein Vorschub von maximal 1/2 Eckenradius
Niemals max. ap mit max. Vorschub
Mit RNGN- und SNGN- Solid -Wendeplatten können deutlich höhere Spantiefen und Vorschübe realisiert werden.

 Gehärteter Stahl 42 - 72 HRC
(Einsatzstahl, Vergütungsstahl, Werkzeugstahl, Kugelstahl)
Hardened Steel 42 - 72 HRC
(Case Hardened Steel, Tool Steel, Heat Treated Steel)

Schnittverhältnisse | cutting conditions

-  Glatter Schnitt
continuous cut
-  Leicht unterbrochener Schnitt
light interrupted cut
-  Unterbrochener Schnitt
interrupted cut

Werkstoff | material

		unbeschichtet uncoated														
		P25			P45			K65			K85			S95		
		V _c [m/min]	a _p [mm]	F [mm/U]	V _c [m/min]	a _p [mm]	F [mm/U]	V _c [m/min]	a _p [mm]	F [mm/U]	V _c [m/min]	a _p [mm]	F [mm/U]	V _c [m/min]	a _p [mm]	F [mm/U]
		○			○ ◻ ◻			○ ◻ ◻			◻ ◻			○ ◻		
Grauguss grey cast iron	min							350	0,01	0,01	350	0,01	0,01	400	0,01	0,01
	med							800	0,20	0,14	600	0,16	0,12	800	0,20	0,14
	max							2000	2,80	0,35	1400	2,80	0,35	1600	2,80	0,35
Kugelgraphitguss ductile graphite iron	min							250	0,01	0,01	200	0,01	0,01	200	0,01	0,01
	med							400	0,20	0,14	350	0,16	0,12	350	0,20	0,14
	max							1200	2,80	0,35	1000	2,80	0,35	1200	2,80	0,35
Hartguss chilled cast iron	min							80	0,01	0,01	80	0,01	0,01	80	0,01	0,01
	med							120	0,12	0,12	100	0,10	0,10	120	0,12	0,12
	max							200	2,50	0,30	180	2,50	0,30	200	2,50	0,30
Sinterstahl sintered steel	min	200	0,01	0,01	180	0,01	0,01	200	0,01	0,01				200	0,01	0,01
	med	300	0,20	0,12	280	0,15	0,10	300	0,20	0,12				300	0,20	0,12
	max	400	2,50	0,30	300	2,00	0,30	400	2,50	0,30				400	2,50	0,30
Ni-, Co- und Fe-Basis-Legierungen Ni- Co- and Fe-base alloy	min							80	0,01	0,01				80	0,01	0,01
	med							180	0,15	0,15				180	0,15	0,15
	max							350	0,50	0,30				350	0,50	0,30
Stellite	min							80	0,01	0,06				80	0,01	0,06
	med							100	1,00	0,12				100	1,00	0,12
	max							140	2,50	0,25				140	2,50	0,25
Titan titanium	min							80	0,01	0,01				80	0,01	0,01
	med							140	0,10	0,12				140	0,10	0,12
	max							240	0,50	0,30				240	0,50	0,30

 Sinterstahl (Sint D Sorten, gehärteter Sinterstahl)
Sintered Steel (Sint D Grades, Hardened Sintermetal)

 Sinterstahl, Guss, Superalloys, Titanium Alloy,
Stellite, Hard Facing | Sintered Steel, Cast Iron

 Grauguss, Werkzeugstahl
Grey Cast Iron, Tool Steel (GG20, GG25, GG30)

 Gusseisen mit Kugelgraphit, Pulverstahl
Ductile Graphite Iron, Powder Steel (GGG40, GGG50, GGG60)

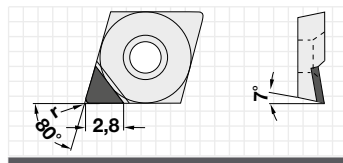

	H25	H45	H65	H85	H95
	beschichtet coated				
ISO-Code	DTS Code	DTS Code	DTS Code	DTS Code	DTS Code
CCGT 06 02 02	TI5010-0100	TI5010-0101	TI5010-0102	TI5010-0103	TI5010-0104
CCGT 06 02 04	TI5010-0105	TI5010-0106	TI5010-0107	TI5010-0108	TI5010-0109
CCGT 06 02 08	TI5010-0110	TI5010-0111	TI5010-0112	TI5010-0113	TI5010-0114
CCGT 09 T3 02	TI5010-0120	TI5010-0121	TI5010-0122	TI5010-0123	TI5010-0124
CCGT 09 T3 04	TI5010-0125	TI5010-0126	TI5010-0127	TI5010-0128	TI5010-0129
CCGT 09 T3 08	TI5010-0130	TI5010-0131	TI5010-0132	TI5010-0133	TI5010-0134

	P25	P45	K65	K85	S95
	unbeschichtet uncoated		unbeschichtet uncoated		unbeschichtet uncoated
DTS Code	DTS Code	DTS Code	DTS Code	DTS Code	DTS Code
TI5510-0100	TI5510-0101	TI5510-0102	TI5510-0103	TI5510-0104	
TI5510-0105	TI5510-0106	TI5510-0107	TI5510-0108	TI5510-0109	
TI5510-0110	TI5510-0111	TI5510-0112	TI5510-0113	TI5510-0114	
TI5510-0120	TI5510-0121	TI5510-0122	TI5510-0123	TI5510-0124	
TI5510-0125	TI5510-0126	TI5510-0127	TI5510-0128	TI5510-0129	
TI5510-0130	TI5510-0131	TI5510-0132	TI5510-0133	TI5510-0134	



Klemmhalter | Toolholder

SCLC...06
A/E...SCLC.06

SCLC...09
A/E...SCLC.09

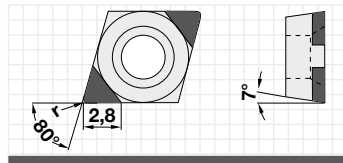

	H25	H45	H65	H85	H95
	beschichtet coated				
ISO-Code	DTS Code	DTS Code	DTS Code	DTS Code	DTS Code
CCGW 06 02 01	TI5010-0139				
CCGW 06 02 02	TI5010-0140	TI5010-0141	TI5010-0142	TI5010-0143	TI5010-0144
CCGW 06 02 04	TI5010-0145	TI5010-0146	TI5010-0147	TI5010-0148	TI5010-0149
CCGW 06 02 08	TI5010-0150	TI5010-0151	TI5010-0152	TI5010-0153	TI5010-0154
CCGW 09 T3 01	TI5010-1205				
CCGW 09 T3 02	TI5010-0160	TI5010-0161	TI5010-0162	TI5010-0163	TI5010-0164
CCGW 09 T3 04	TI5010-0165	TI5010-0166	TI5010-0167	TI5010-0168	TI5010-0169
CCGW 09 T3 08	TI5010-0170	TI5010-0171	TI5010-0172	TI5010-0173	TI5010-0174
CCGW 12 04 02	TI5010-0180	TI5010-0181	TI5010-0182	TI5010-0183	TI5010-0184
CCGW 12 04 04	TI5010-0185	TI5010-0186	TI5010-0187	TI5010-0188	TI5010-0189
CCGW 12 04 08	TI5010-0190	TI5010-0191	TI5010-0192	TI5010-0193	TI5010-0194
CCGW 12 04 12	TI5010-0195	TI5010-0196	TI5010-0197	TI5010-0198	TI5010-0199
CCGW 09 T3 02					
CCGW 09 T3 04	TI5010-0210	TI5010-0211	TI5010-0212	TI5010-0213	TI5010-0214
CCGW 09 T3 08	TI5010-0215	TI5010-0216	TI5010-0217	TI5010-0218	TI5010-0219
CCGW 12 04 04	TI5010-0225	TI5010-0226	TI5010-0227	TI5010-0228	TI5010-0229
CCGW 12 04 08	TI5010-0230	TI5010-0231	TI5010-0232	TI5010-0233	TI5010-0234
CCGW 12 04 12	TI5010-0235	TI5010-0236	TI5010-0237	TI5010-0238	TI5010-0239

	P25	P45	K65	K85	S95
	unbeschichtet uncoated		unbeschichtet uncoated		unbeschichtet uncoated
DTS Code	DTS Code	DTS Code	DTS Code	DTS Code	DTS Code
			TI5510-0139		
TI5510-0140	TI5510-0141	TI5510-0142	TI5510-0143	TI5510-0144	
TI5510-0145	TI5510-0146	TI5510-0147	TI5510-0148	TI5510-0149	
TI5510-0150	TI5510-0151	TI5510-0152	TI5510-0153	TI5510-0154	
		TI5510-1205			
TI5510-0160	TI5510-0161	TI5510-0162	TI5510-0163	TI5510-0164	
TI5510-0165	TI5510-0166	TI5510-0167	TI5510-0168	TI5510-0169	
TI5510-0170	TI5510-0171	TI5510-0172	TI5510-0173	TI5510-0174	
TI5510-0180	TI5510-0181	TI5510-0182	TI5510-0183	TI5510-0184	
TI5510-0185	TI5510-0186	TI5510-0187	TI5510-0188	TI5510-0189	
TI5510-0190	TI5510-0191	TI5510-0192	TI5510-0193	TI5510-0194	
TI5510-0195	TI5510-0196	TI5510-0197	TI5510-0198	TI5510-0199	
TI5510-0205	TI5510-0206	TI5510-0207	TI5510-0208	TI5510-0209	
TI5510-0210	TI5510-0211	TI5510-0212	TI5510-0213	TI5510-0214	
TI5510-0215	TI5510-0216	TI5510-0217	TI5510-0218	TI5510-0219	
TI5510-0225	TI5510-0226	TI5510-0227	TI5510-0228	TI5510-0229	
TI5510-0230	TI5510-0231	TI5510-0232	TI5510-0233	TI5510-0234	
TI5510-0235	TI5510-0236	TI5510-0237	TI5510-0238	TI5510-0239	



Klemmhalter | Toolholder

SCLC...06
A/E...SCLC.06

SCLC...09
A/E...SCLC.09

SCLC...12
A...SCLC.12

SCLC...09
A...SCLC.09

SCLC...12
A...SCLC.12

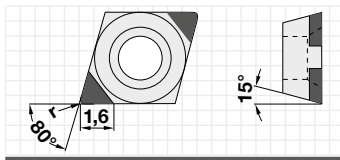

ISO-Code
CDGW 04 01 01
CDGW 04 01 02
CDGW 04 01 04

H25	H45	H65	H85	H95
beschichtet coated				
○	○ ◻ ◻	○ ◻ ◻	◻ ◻	○ ◻
DTS Code	DTS Code	DTS Code	DTS Code	DTS Code
		TI5010-1511		
		TI5010-1512		
		TI5010-1513		

P25	P45	K65	K85	S95
unbeschichtet uncoated		unbeschichtet uncoated		unbeschichtet uncoated
○ ◻	◻ ◻	○ ◻ ◻	◻ ◻	○ ◻
DTS Code	DTS Code	DTS Code	DTS Code	DTS Code



Klemmhalter Toolholder
E... SCLD. 04

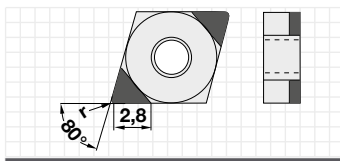

ISO-Code
CNGA 12 04 02
CNGA 12 04 04
CNGA 12 04 08
CNGA 12 04 12

H25	H45	H65	H85	H95
beschichtet coated				
○	○ ◻ ◻	○ ◻ ◻	◻ ◻	○ ◻
DTS Code	DTS Code	DTS Code	DTS Code	DTS Code
TI5010-0245	TI5010-0246	TI5010-0247	TI5010-0248	TI5010-0249
TI5010-0250	TI5010-0251	TI5010-0252	TI5010-0253	TI5010-0254
TI5010-0255	TI5010-0256	TI5010-0257	TI5010-0258	TI5010-0259
TI5010-0260	TI5010-0261	TI5010-0262	TI5010-0263	TI5010-0264
TI5010-0270	TI5010-0271	TI5010-0272	TI5010-0273	TI5010-0274
TI5010-0275	TI5010-0276	TI5010-0277	TI5010-0278	TI5010-0279
TI5010-0280	TI5010-0281	TI5010-0282	TI5010-0283	TI5010-0284
TI5010-0285	TI5010-0286	TI5010-0287	TI5010-0288	TI5010-0289

P25	P45	K65	K85	S95
unbeschichtet uncoated		unbeschichtet uncoated		unbeschichtet uncoated
○ ◻	◻ ◻	○ ◻ ◻	◻ ◻	○ ◻
DTS Code	DTS Code	DTS Code	DTS Code	DTS Code
TI5510-0245	TI5510-0246	TI5510-0247	TI5510-0248	TI5510-0249
TI5510-0250	TI5510-0251	TI5510-0252	TI5510-0253	TI5510-0254
TI5510-0255	TI5510-0256	TI5510-0257	TI5510-0258	TI5510-0259
TI5510-0260	TI5510-0261	TI5510-0262	TI5510-0263	TI5510-0264
TI5510-0270	TI5510-0271	TI5510-0272	TI5510-0273	TI5510-0274
TI5510-0275	TI5510-0276	TI5510-0277	TI5510-0278	TI5510-0279
TI5510-0280	TI5510-0281	TI5510-0282	TI5510-0283	TI5510-0284
TI5510-0285	TI5510-0286	TI5510-0287	TI5510-0288	TI5510-0289



Klemmhalter Toolholder
DCLN..12 A...PCLN.12
DCLN..12 A...PCLN.12

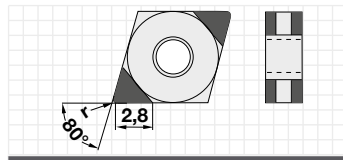

	H25	H45	H65	H85	H95	P25	P45	K65	K85	S95	Klemmhalter Toolholder	
	beschichtet coated					unbeschichtet uncoated		unbeschichtet uncoated		unbeschichtet uncoated		
ISO-Code	DTS Code	DTS Code	DTS Code	DTS Code	DTS Code	DTS Code	DTS Code	DTS Code	DTS Code	DTS Code		
Standard	CNGA 1204 02	TI5010-0295	TI5010-0296	TI5010-0297	TI5010-0298	TI5010-0299	TI5510-0295	TI5510-0296	TI5510-0297	TI5510-0298	TI5510-0299	DCLN..12 A...PCLN.12
	CNGA 1204 04	TI5010-0300	TI5010-0301	TI5010-0302	TI5010-0303	TI5010-0304	TI5510-0300	TI5510-0301	TI5510-0302	TI5510-0303	TI5510-0304	
	CNGA 1204 08	TI5010-0305	TI5010-0306	TI5010-0307	TI5010-0308	TI5010-0309	TI5510-0305	TI5510-0306	TI5510-0307	TI5510-0308	TI5510-0309	
	CNGA 1204 12	TI5010-0310	TI5010-0311	TI5010-0312	TI5010-0313	TI5010-0314	TI5510-0310	TI5510-0311	TI5510-0312	TI5510-0313	TI5510-0314	
Wiper	CNGA 1204 02	TI5010-0320	TI5010-0321	TI5010-0322	TI5010-0323	TI5010-0324	TI5510-0320	TI5510-0321	TI5510-0322	TI5510-0323	TI5510-0324	DCLN..12 A...PCLN.12
	CNGA 1204 04	TI5010-0325	TI5010-0326	TI5010-0327	TI5010-0328	TI5010-0329	TI5510-0325	TI5510-0326	TI5510-0327	TI5510-0328	TI5510-0329	
	CNGA 1204 08	TI5010-0330	TI5010-0331	TI5010-0332	TI5010-0333	TI5010-0334	TI5510-0330	TI5510-0331	TI5510-0332	TI5510-0333	TI5510-0334	
	CNGA 1204 12	TI5010-0335	TI5010-0336	TI5010-0337	TI5010-0338	TI5010-0339	TI5510-0335	TI5510-0336	TI5510-0337	TI5510-0338	TI5510-0339	

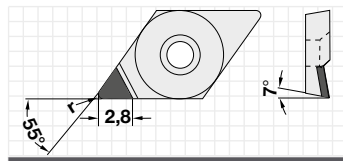

	H25	H45	H65	H85	H95	P25	P45	K65	K85	S95	Klemmhalter Toolholder
	beschichtet coated					unbeschichtet uncoated		unbeschichtet uncoated		unbeschichtet uncoated	
ISO-Code	DTS Code	DTS Code	DTS Code	DTS Code	DTS Code	DTS Code	DTS Code	DTS Code	DTS Code	DTS Code	
DCGT 07 02 02	TI5010-0345	TI5010-0346	TI5010-0347	TI5010-0348	TI5010-0349	TI5510-0345	TI5510-0346	TI5510-0347	TI5510-0348	TI5510-0349	SDJC../SDNCN..07 A...SDUC../A/E...SDQC..07
	TI5010-0350	TI5010-0351	TI5010-0352	TI5010-0353	TI5010-0354	TI5510-0350	TI5510-0351	TI5510-0352	TI5510-0353	TI5510-0354	
	TI5010-0355	TI5010-0356	TI5010-0357	TI5010-0358	TI5010-0359	TI5510-0355	TI5510-0356	TI5510-0357	TI5510-0358	TI5510-0359	
DCGT 11 T3 02	TI5010-0365	TI5010-0366	TI5010-0367	TI5010-0368	TI5010-0369	TI5510-0365	TI5510-0366	TI5510-0367	TI5510-0368	TI5510-0369	SDJC../SDNCN..11 A...SDUC../A/E...SDQC..11
	TI5010-0370	TI5010-0371	TI5010-0372	TI5010-0373	TI5010-0374	TI5510-0370	TI5510-0371	TI5510-0372	TI5510-0373	TI5510-0374	
	TI5010-0375	TI5010-0376	TI5010-0377	TI5010-0378	TI5010-0379	TI5510-0375	TI5510-0376	TI5510-0377	TI5510-0378	TI5510-0379	



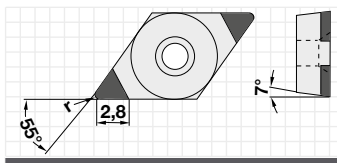

	H25	H45	H65	H85	H95	P25	P45	K65	K85	S95	Klemmhalter Toolholder	
	beschichtet coated					unbeschichtet uncoated		unbeschichtet uncoated		unbeschichtet uncoated		
ISO-Code	DTS Code	DTS Code	DTS Code	DTS Code	DTS Code	DTS Code	DTS Code	DTS Code	DTS Code	DTS Code		
Standard	DCGW 04 T0 01 (CL 2,0)			TI5010-1521							E...SDUC.. 04 E...SDQC.. 04	
	DCGW 04 T0 02 (CL 2,0)			TI5010-1522								
	DCGW 04 T0 04 (CL 2,0)			TI5010-1523								
	DCGW 07 02 01	TI5010-1224						TI5510-1224			SDJC../ SDNCN..07 A...SDUC../ A/E...SDQC..07	
	DCGW 07 02 02	TI5010-0385	TI5010-0386	TI5010-0387	TI5010-0388	TI5010-0389	TI5510-0385	TI5510-0386	TI5510-0387	TI5510-0388		TI5510-0389
	DCGW 07 02 04	TI5010-0390	TI5010-0391	TI5010-0392	TI5010-0393	TI5010-0394	TI5510-0390	TI5510-0391	TI5510-0392	TI5510-0393		TI5510-0394
	DCGW 07 02 08	TI5010-0395	TI5010-0396	TI5010-0397	TI5010-0398	TI5010-0399	TI5510-0395	TI5510-0396	TI5510-0397	TI5510-0398		TI5510-0399
	DCGW 11 T3 01	TI5010-1225							TI5510-1225			SDJC../ SDNCN..11 A...SDUC../ A/E...SDQC..11
	DCGW 11 T3 02	TI5010-0405	TI5010-0406	TI5010-0407	TI5010-0408	TI5010-0409	TI5510-0405	TI5510-0406	TI5510-0407	TI5510-0408	TI5510-0409	
	DCGW 11 T3 04	TI5010-0410	TI5010-0411	TI5010-0412	TI5010-0413	TI5010-0414	TI5510-0410	TI5510-0411	TI5510-0412	TI5510-0413	TI5510-0414	
DCGW 11 T3 08	TI5010-0415	TI5010-0416	TI5010-0417	TI5010-0418	TI5010-0419	TI5510-0415	TI5510-0416	TI5510-0417	TI5510-0418	TI5510-0419		
Wiper	DCGW 07 02 04	TI5010-0425	TI5010-0426	TI5010-0427	TI5010-0428	TI5010-0429	TI5510-0425	TI5510-0426	TI5510-0427	TI5510-0428	TI5510-0429	SDJC...07 A...SDUC.
	DCGW 07 02 08	TI5010-0430	TI5010-0431	TI5010-0432	TI5010-0433	TI5010-0434	TI5510-0430	TI5510-0431	TI5510-0432	TI5510-0433	TI5510-0434	
	DCGW 11 T3 04	TI5010-0440	TI5010-0441	TI5010-0442	TI5010-0443	TI5010-0444	TI5510-0440	TI5510-0441	TI5510-0442	TI5510-0443	TI5510-0444	SDJC...11 A...SDUC.
	DCGW 11 T3 08	TI5010-0445	TI5010-0446	TI5010-0447	TI5010-0448	TI5010-0449	TI5510-0445	TI5510-0446	TI5510-0447	TI5510-0448	TI5510-0449	

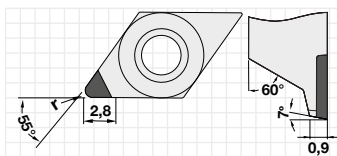

	H25	H45	H65	H85	H95	P25	P45	K65	K85	S95	Klemmhalter Toolholder
	unbeschichtet uncoated					unbeschichtet uncoated		unbeschichtet uncoated			
ISO-Code	DTS Code										
DXGW 11 T3 01	TI5010-1600							TI5510-1600			SDJX.. / SDNXN 11
DXGW 11 T3 02	TI5010-1605							TI5510-1605			
DXGW 11 T3 04	TI5010-1610							TI5510-1610			
DXGW 11 T3 08	TI5010-1615							TI5510-1615			

Weitere Sonderwerkzeuge
gerne auf Anfrage
Special tools on request
info@diamond-toolingsystems.com

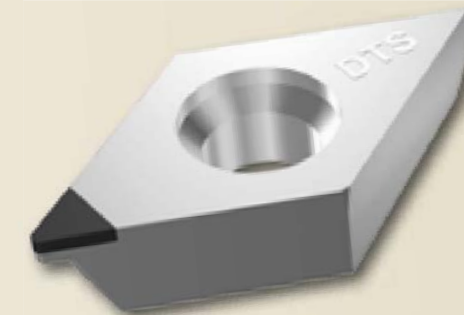

Spezialausführung
Special Type

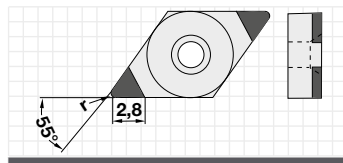

	H25	H45	H65	H85	H95	P25	P45	K65	K85	S95	Klemmhalter Toolholder	
	beschichtet coated					unbeschichtet uncoated		unbeschichtet uncoated		unbeschichtet uncoated		
	○	○ ⊕ ⊖	○ ⊕ ⊖	⊕ ⊖	○ ⊕	○ ⊕	⊕ ⊖	○ ⊕ ⊖	⊕ ⊖	○ ⊕		
ISO-Code	DTS Code	DTS Code	DTS Code	DTS Code	DTS Code	DTS Code	DTS Code	DTS Code	DTS Code	DTS Code		
Standard	DNGA 15 04 01	TI5010-0470						TI5510-0472			DDJN..15(04)	
	DNGA 15 04 02	TI5010-0475	TI5010-0476	TI5010-0477	TI5010-0478	TI5010-0479	TI5510-0475	TI5510-0476	TI5510-0477	TI5510-0478		TI5510-0479
	DNGA 15 04 04	TI5010-0480	TI5010-0481	TI5010-0482	TI5010-0483	TI5010-0484	TI5510-0480	TI5510-0481	TI5510-0482	TI5510-0483		TI5510-0484
	DNGA 15 04 08	TI5010-0485	TI5010-0486	TI5010-0487	TI5010-0488	TI5010-0489	TI5510-0485	TI5510-0486	TI5510-0487	TI5510-0488		TI5510-0489
	DNGA 15 04 12	TI5010-0490	TI5010-0491	TI5010-0492	TI5010-0493	TI5010-0494	TI5510-0490	TI5510-0491	TI5510-0492	TI5510-0493		TI5510-0494
	DNGA 15 06 01	TI5010-0495							TI5510-0497			DDJN..15(06)
	DNGA 15 06 02	TI5010-0500	TI5010-0501	TI5010-0502	TI5010-0503	TI5010-0504	TI5510-0500	TI5510-0501	TI5510-0502	TI5510-0503	TI5510-0504	
	DNGA 15 06 04	TI5010-0505	TI5010-0506	TI5010-0507	TI5010-0508	TI5010-0509	TI5510-0505	TI5510-0506	TI5510-0507	TI5510-0508	TI5510-0509	
	DNGA 15 06 08	TI5010-0510	TI5010-0511	TI5010-0512	TI5010-0513	TI5010-0514	TI5510-0510	TI5510-0511	TI5510-0512	TI5510-0513	TI5510-0514	
	DNGA 15 06 12	TI5010-0515	TI5010-0516	TI5010-0517	TI5010-0518	TI5010-0519	TI5510-0515	TI5510-0516	TI5510-0517	TI5510-0518	TI5510-0519	
Wiper	DNGA 15 04 04	TI5010-0525	TI5010-0526	TI5010-0527	TI5010-0528	TI5010-0529	TI5510-0525	TI5510-0526	TI5510-0527	TI5510-0528	TI5510-0529	DDJN..15(04)
	DNGA 15 04 08	TI5010-0530	TI5010-0531	TI5010-0532	TI5010-0533	TI5010-0534	TI5510-0530	TI5510-0531	TI5510-0532	TI5510-0533	TI5510-0534	
	DNGA 15 06 04	TI5010-0535	TI5010-0536	TI5010-0537	TI5010-0538	TI5010-0539	TI5510-0535	TI5510-0536	TI5510-0537	TI5510-0538	TI5510-0539	DDJN..15(06)
	DNGA 15 06 08	TI5010-0540	TI5010-0541	TI5010-0542	TI5010-0543	TI5010-0544	TI5510-0540	TI5510-0541	TI5510-0542	TI5510-0543	TI5510-0544	

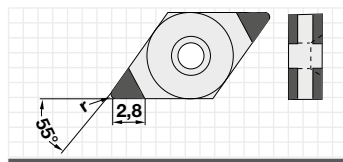

	H25	H45	H65	H85	H95	P25	P45	K65	K85	S95	Klemmhalter Toolholder	
	beschichtet coated					unbeschichtet uncoated		unbeschichtet uncoated		unbeschichtet uncoated		
	○	○ ⊕ ⊖	○ ⊕ ⊖	⊕ ⊖	○ ⊕	○ ⊕	⊕ ⊖	○ ⊕ ⊖	⊕ ⊖	○ ⊕		
ISO-Code	DTS Code	DTS Code	DTS Code	DTS Code	DTS Code	DTS Code	DTS Code	DTS Code	DTS Code	DTS Code		
Standard	DNGA 15 04 02	TI5010-0570	TI5010-0571	TI5010-0572	TI5010-0573	TI5010-0574	TI5510-0570	TI5510-0571	TI5510-0572	TI5510-0573	TI5510-0574	DDJN..15(04)
	DNGA 15 04 04	TI5010-0575	TI5010-0576	TI5010-0577	TI5010-0578	TI5010-0579	TI5510-0575	TI5510-0576	TI5510-0577	TI5510-0578	TI5510-0579	
	DNGA 15 04 08	TI5010-0580	TI5010-0581	TI5010-0582	TI5010-0583	TI5010-0584	TI5510-0580	TI5510-0581	TI5510-0582	TI5510-0583	TI5510-0584	
	DNGA 15 04 12	TI5010-0585	TI5010-0586	TI5010-0587	TI5010-0588	TI5010-0589	TI5510-0585	TI5510-0586	TI5510-0587	TI5510-0588	TI5510-0589	
	DNGA 15 06 02	TI5010-0595	TI5010-0596	TI5010-0597	TI5010-0598	TI5010-0599	TI5510-0595	TI5510-0596	TI5510-0597	TI5510-0598	TI5510-0599	DDJN..15(06)
	DNGA 15 06 04	TI5010-0600	TI5010-0601	TI5010-0602	TI5010-0603	TI5010-0604	TI5510-0600	TI5510-0601	TI5510-0602	TI5510-0603	TI5510-0604	
	DNGA 15 06 08	TI5010-0605	TI5010-0606	TI5010-0607	TI5010-0608	TI5010-0609	TI5510-0605	TI5510-0606	TI5510-0607	TI5510-0608	TI5510-0609	
	DNGA 15 06 12	TI5010-0610	TI5010-0611	TI5010-0612	TI5010-0613	TI5010-0614	TI5510-0610	TI5510-0611	TI5510-0612	TI5510-0613	TI5510-0614	
Wiper	DNGA 15 04 04	TI5010-0620	TI5010-0621	TI5010-0622	TI5010-0623	TI5010-0624	TI5510-0620	TI5510-0621	TI5510-0622	TI5510-0623	TI5510-0624	DDJN..15(04)
	DNGA 15 04 08	TI5010-0625	TI5010-0626	TI5010-0627	TI5010-0628	TI5010-0629	TI5510-0625	TI5510-0626	TI5510-0627	TI5510-0628	TI5510-0629	
	DNGA 15 06 04	TI5010-0630	TI5010-0631	TI5010-0632	TI5010-0633	TI5010-0634	TI5510-0630	TI5510-0631	TI5510-0632	TI5510-0633	TI5510-0634	DDJN..15(06)
	DNGA 15 06 08	TI5010-0635	TI5010-0636	TI5010-0637	TI5010-0638	TI5010-0639	TI5510-0635	TI5510-0636	TI5510-0637	TI5510-0638	TI5510-0639	



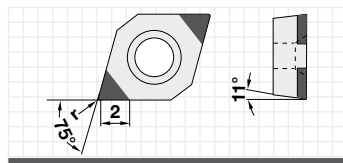

	H25	H45	H65	H85	H95
			beschichtet coated		
	○	○ ○ ○	○ ○ ○	○ ○	○ ○
ISO-Code	DTS Code	DTS Code	DTS Code	DTS Code	DTS Code
EPGW 05 02 01			TI5010-1531		
EPGW 05 02 02			TI5010-1532		
EPGW 05 02 04			TI5010-1533		

	P25	P45	K65	K85	S95
	unbeschichtet uncoated		unbeschichtet uncoated		unbeschichtet uncoated
	○ ○	○ ○	○ ○ ○	○ ○	○ ○
ISO-Code	DTS Code	DTS Code	DTS Code	DTS Code	DTS Code



Klemmhalter | Toolholder
E... SELP.05

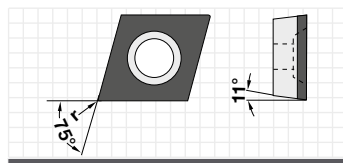

	H25	H45	H65	H85	H95	P25	P45	K65	K85	S95
			beschichtet coated					unbeschichtet uncoated		
			○ ○ ○					○ ○ ○		
ISO-Code			DTS Code					DTS Code		
EPGW 05 02 01-FF			TI5030-0081					TI5530-0081		
EPGW 05 02 02-FF			TI5030-0082					TI5530-0082		
EPGW 05 02 04-FF			TI5030-0083					TI5530-0083		



Klemmhalter | Toolholder
E... SELP. 05

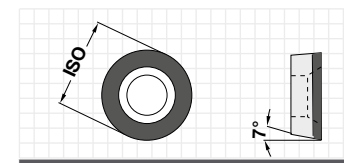

	H25	H45	H65	H85	H95	P25	P45	K65	K85	S95
			beschichtet coated					unbeschichtet uncoated		
			○ ○ ○					○ ○ ○		
ISO-Code			DTS Code					DTS Code		
RCGW 06 02 M0-FF			TI5030-0100					TI5530-0102		
RCGW 08 03 M0-FF			TI5030-0105					TI5530-0107		
RCGW 10 03 M0-FF			TI5030-0115					TI5530-0117		SRDCN. / SRGC ...1003 E...SRLC.1003
RCGW 10 T3 M0-FF			TI5030-0120					TI5530-0122		SRDCN. / SRGC ...10T3
RCGW 12 04 M0-FF			TI5030-0125					TI5530-0127		SRDCN. / SRGC ...12



Klemmhalter | Toolholder
SRDCN. / SRGC ...06 | E...SRLC.06
SRDCN. / SRGC ...08 | E...SRLC.08
SRDCN. / SRGC ...1003 | E...SRLC.1003
SRDCN. / SRGC ...10T3
SRDCN. / SRGC ...12

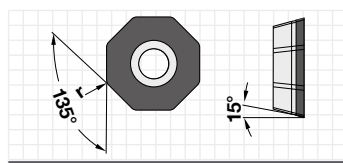

	H25	H45	H65	H85	H95	P25	P45	K65	K85	S95
			beschichtet coated					unbeschichtet uncoated		
			○ ○ ○					○ ○ ○		
ISO-Code			DTS Code					DTS Code		
ODGW 05 T3 02-FF			MI5030-0100					MI5530-0100		
ODGW 05 T3 04-FF			MI5030-0102					MI5530-0102		
ODGW 05 T3 08-FF			MI5030-0104					MI5530-0104		

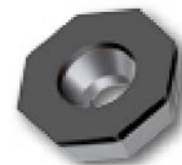

Klemmhalter | Toolholder
SOXDR/L ...05

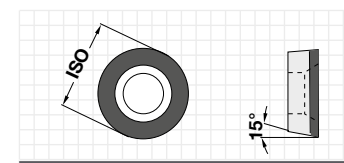

	H25	H45	H65	H85	H95	P25	P45	K65	K85	S95
			beschichtet coated					unbeschichtet uncoated		
			○ ○ ○					○ ○ ○		
ISO-Code			DTS Code					DTS Code		
RDHX 07 02 M0 T-FF			MI5030-0135					MI5530-0137		
RDHX 10 03 M0 T-FF			MI5030-0140					MI5530-0142		
RDHX 12 T3 M0 T-FF			MI5030-0145					MI5530-0147		



Klemmhalter | Toolholder
Fräsplatte
Milling insert

RBGN | FullFace

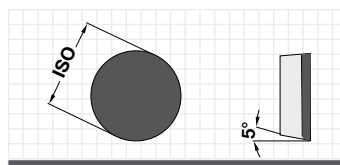

ISO-Code	H25		H45		H65		H85		H95		P25		P45		K65		K85	S95
	beschichtet coated																	
	○		○		○		○		○		○		○		○		○	○
DTS Code	DTS Code		DTS Code		DTS Code		DTS Code		DTS Code		DTS Code		DTS Code		DTS Code		DTS Code	DTS Code
RBGN 06 02 M0-FF	TI5030-0090		TI5030-0090		TI5530-0090		TI5530-0090		TI5530-0090		TI5530-0090		TI5530-0090		TI5530-0090		CRDBN / CRSBR/L ...06	
RBGN 08 03 M0-FF	TI5030-0092		TI5030-0092		TI5530-0092		TI5530-0092		TI5530-0092		TI5530-0092		TI5530-0092		TI5530-0092		CRDBN / CRSBR/L ...08	
RBGN 10 03 M0-FF	TI5030-0094		TI5030-0094		TI5530-0094		TI5530-0094		TI5530-0094		TI5530-0094		TI5530-0094		TI5530-0094		CRDBN / CRSBR/L ...10	
RBGN 12 03 M0-FF	TI5030-0096		TI5030-0096		TI5530-0096		TI5530-0096		TI5530-0096		TI5530-0096		TI5530-0096		TI5530-0096		CRDBN / CRSBR/L ...12	



Klemmhalter | Toolholder

RNGN | Solid

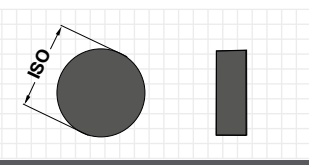

ISO-Code	H25		H45		H65		H85		H95		P25		P45		K65		K85	S95
	beschichtet coated																	
	○		○		○		○		○		○		○		○		○	○
DTS Code	DTS Code		DTS Code		DTS Code		DTS Code		DTS Code		DTS Code		DTS Code		DTS Code		DTS Code	DTS Code
RNGN 06 03 00	TI5040-0090		TI5040-0090		TI5540-0090		TI5540-0090		TI5540-0090		TI5540-0090		TI5540-0090		TI5540-0090		CRSN. / CRDNN ...0603	
RNGN 06 04 00	TI5040-0091		TI5040-0091		TI5540-0091		TI5540-0091		TI5540-0091		TI5540-0091		TI5540-0091		TI5540-0091		CRSN. / CRDNN ...0604	
RNGN 09 03 00	TI5040-0100		TI5040-0100		TI5540-0100		TI5540-0100		TI5540-0100		TI5540-0100		TI5540-0100		TI5540-0100		CRSN. / CRDNN ...1203	
RNGN 09 04 00	TI5040-0105		TI5040-0105		TI5540-0105		TI5540-0105		TI5540-0105		TI5540-0105		TI5540-0105		TI5540-0105		CRSN. / CRDNN ...1204	
RNGN 12 03 00	TI5040-0115		TI5040-0115		TI5540-0115		TI5540-0115		TI5540-0115		TI5540-0115		TI5540-0115		TI5540-0115		CRSN. / CRDNN ...1203	
RNGN 12 04 00	TI5040-0120		TI5040-0120		TI5540-0120		TI5540-0120		TI5540-0120		TI5540-0120		TI5540-0120		TI5540-0120		CRSN. / CRDNN ...1204	



Klemmhalter | Toolholder

SCGW | Z4

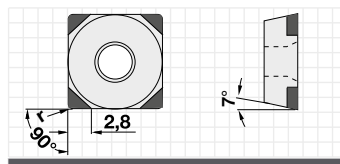

ISO-Code	H25	H45	H65	H85	H95
	beschichtet coated				
	○	○	○	○	○
DTS Code	DTS Code	DTS Code	DTS Code	DTS Code	DTS Code
SCGW 09 T3 02	TI5010-0645	TI5010-0646	TI5010-0647	TI5010-0648	TI5010-0649
SCGW 09 T3 04	TI5010-0650	TI5010-0651	TI5010-0652	TI5010-0653	TI5010-0654
SCGW 09 T3 08	TI5010-0655	TI5010-0656	TI5010-0657	TI5010-0658	TI5010-0659
SCGW 12 04 02	TI5010-0665	TI5010-0666	TI5010-0667	TI5010-0668	TI5010-0669
SCGW 12 04 04	TI5010-0670	TI5010-0671	TI5010-0672	TI5010-0673	TI5010-0674
SCGW 12 04 08	TI5010-0675	TI5010-0676	TI5010-0677	TI5010-0678	TI5010-0679
SCGW 12 04 12	TI5010-0680	TI5010-0681	TI5010-0682	TI5010-0683	TI5010-0684

ISO-Code	P25		P45		K65		K85		S95	
	beschichtet coated									
	○		○		○		○		○	
DTS Code	DTS Code		DTS Code		DTS Code		DTS Code		DTS Code	
SSDCN ...09	TI5510-0645	TI5510-0646	TI5510-0647	TI5510-0648	TI5510-0649	TI5510-0650	TI5510-0651	TI5510-0652	TI5510-0653	TI5510-0654
SSDCN ...12	TI5510-0655	TI5510-0656	TI5510-0657	TI5510-0658	TI5510-0659	TI5510-0665	TI5510-0666	TI5510-0667	TI5510-0668	TI5510-0669
	TI5510-0670	TI5510-0671	TI5510-0672	TI5510-0673	TI5510-0674	TI5510-0675	TI5510-0676	TI5510-0677	TI5510-0678	TI5510-0679
	TI5510-0680	TI5510-0681	TI5510-0682	TI5510-0683	TI5510-0684					



Klemmhalter | Toolholder

SNGA | Z4

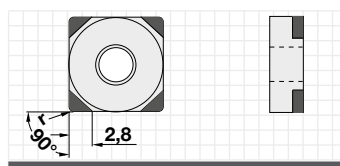

ISO-Code	H25	H45	H65	H85	H95
	beschichtet coated				
	○	○	○	○	○
DTS Code	DTS Code	DTS Code	DTS Code	DTS Code	DTS Code
SNGA 12 04 04	TI5010-0690	TI5010-0691	TI5010-0692	TI5010-0693	TI5010-0694
SNGA 12 04 08	TI5010-0695	TI5010-0696	TI5010-0697	TI5010-0698	TI5010-0699
SNGA 12 04 12	TI5010-0700	TI5010-0701	TI5010-0702	TI5010-0703	TI5010-0704

ISO-Code	P25		P45		K65		K85		S95	
	beschichtet coated									
	○		○		○		○		○	
DTS Code	DTS Code		DTS Code		DTS Code		DTS Code		DTS Code	
DSBN. / DSDNN ...12	TI5510-0690	TI5510-0691	TI5510-0692	TI5510-0693	TI5510-0694	TI5510-0695	TI5510-0696	TI5510-0697	TI5510-0698	TI5510-0699
	TI5510-0700	TI5510-0701	TI5510-0702	TI5510-0703	TI5510-0704					



Klemmhalter | Toolholder

- Glatter Schnitt continuous cut
- Leicht unterbrochener Schnitt light interrupted cut
- Stark unterbrochener Schnitt heavy interrupted cut

● Gehärteter Stahl 42 - 72 HRC
(Einsatzstahl, Vergütungsstahl, Werkzeugstahl, Kugelstahl)
Hardened Steel 42 - 72 HRC
(Case Hardened Steel, Tool Steel, Heat Treated Steel)

● Sinterstahl (Sint D Sorten, gehärteter Sinterstahl)
Sintered Steel (Sint D Grades, Hardened Sintermetal)

● Sinterstahl, Guss, Superalloys, Titanium Alloy,
Stellite, Hard Facing | Sintered Steel, Cast Iron

● Grauguss, Werkzeugstahl
Grey Cast Iron, Tool Steel (GG20, GG25, GG30)

● Gusseisen mit Kugelgraphit, Pulverstahl
Ductile Graphite Iron, Powder Steel (GGG40, GGG50, GGG60)

Unser komplettes Halter-Programm finden Sie in unserem Klemmhalter- und Bohrstangen-Katalogen.
For complete tool holder program please check our tool holder- and boring bar catalogue.

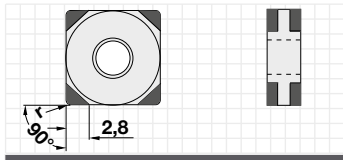

	H25	H45	H65	H85	H95
	beschichtet coated				
	○	○ ⊕ ⊕	○ ⊕ ⊕	⊕ ⊕	○ ⊕
ISO-Code	DTS Code	DTS Code	DTS Code	DTS Code	DTS Code
SNGA 1204 04	TI5010-0710	TI5010-0711	TI5010-0712	TI5010-0713	TI5010-0714
SNGA 1204 08	TI5010-0715	TI5010-0716	TI5010-0717	TI5010-0718	TI5010-0719
SNGA 1204 12	TI5010-0720	TI5010-0721	TI5010-0722	TI5010-0723	TI5010-0724

	P25	P45	K65	K85	S95
	unbeschichtet uncoated		unbeschichtet uncoated		unbeschichtet uncoated
	○ ⊕	⊕ ⊕	○ ⊕ ⊕	⊕ ⊕	○ ⊕
DTS Code	DTS Code	DTS Code	DTS Code	DTS Code	DTS Code
TI5510-0710	TI5510-0711	TI5510-0712	TI5510-0713	TI5510-0714	
TI5510-0715	TI5510-0716	TI5510-0717	TI5510-0718	TI5510-0719	
TI5510-0720	TI5510-0721	TI5510-0722	TI5510-0723	TI5510-0724	



Klemmhalter | Toolholder
DSBN. / DSDNN ...12

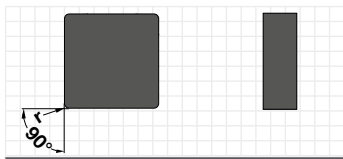

	H25	H45	H65	H85	H95
	unbeschichtet uncoated				
	○	○ ⊕ ⊕	○ ⊕ ⊕	⊕ ⊕	○ ⊕
ISO-Code	DTS Code	DTS Code	DTS Code	DTS Code	DTS Code
SNGN 0903 04			TI5040-0130		
SNGN 0903 08			TI5040-0135		
SNGN 0903 12			TI5040-0140		
SNGN 1204 04			TI5040-0145		
SNGN 1204 08			TI5040-0150		
SNGN 1204 12			TI5040-0155		
SNGN 1204 16			TI5040-0160		

	P25	P45	K65	K85	S95
	unbeschichtet uncoated		unbeschichtet uncoated		unbeschichtet uncoated
	○ ⊕	⊕ ⊕	○ ⊕ ⊕	⊕ ⊕	○ ⊕
DTS Code	DTS Code	DTS Code	DTS Code	DTS Code	DTS Code
			TI5540-0130		
			TI5540-0135		
			TI5540-0140		
			TI5540-0145		
			TI5540-0150		
			TI5540-0155		
			TI5540-0160		



Klemmhalter | Toolholder
CSSN. / CSDNN ...09
CSSN. / CSDNN ...12

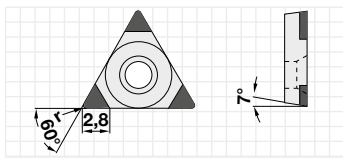

	H25	H45	H65	H85	H95
	beschichtet coated				
	○	○ ⊕ ⊕	○ ⊕ ⊕	⊕ ⊕	○ ⊕
ISO-Code	DTS Code	DTS Code	DTS Code	DTS Code	DTS Code
TCGW 0902 01	TI5010-0725				
TCGW 0902 02	TI5010-0730	TI5010-0731	TI5010-0732	TI5010-0733	TI5010-0734
TCGW 0902 04	TI5010-0735	TI5010-0736	TI5010-0737	TI5010-0738	TI5010-0739
TCGW 0902 08	TI5010-0740	TI5010-0741	TI5010-0742	TI5010-0743	TI5010-0744
TCGW 1102 01	TI5010-0745				
TCGW 1102 02	TI5010-0750	TI5010-0751	TI5010-0752	TI5010-0753	TI5010-0754
TCGW 1102 04	TI5010-0755	TI5010-0756	TI5010-0757	TI5010-0758	TI5010-0759
TCGW 1102 08	TI5010-0760	TI5010-0761	TI5010-0762	TI5010-0763	TI5010-0764
TCGW 16 T302	TI5010-0770	TI5010-0771	TI5010-0772	TI5010-0773	TI5010-0774
TCGW 16 T304	TI5010-0775	TI5010-0776	TI5010-0777	TI5010-0778	TI5010-0779
TCGW 16 T308	TI5010-0780	TI5010-0781	TI5010-0782	TI5010-0783	TI5010-0784

	P25	P45	K65	K85	S95
	unbeschichtet uncoated		unbeschichtet uncoated		unbeschichtet uncoated
	○ ⊕	⊕ ⊕	○ ⊕ ⊕	⊕ ⊕	○ ⊕
DTS Code	DTS Code	DTS Code	DTS Code	DTS Code	DTS Code
TI5510-0730	TI5510-0731	TI5510-0732	TI5510-0733	TI5510-0734	
TI5510-0735	TI5510-0736	TI5510-0737	TI5510-0738	TI5510-0739	
TI5510-0740	TI5510-0741	TI5510-0742	TI5510-0743	TI5510-0744	
TI5510-0750	TI5510-0751	TI5510-0752	TI5510-0753	TI5510-0754	
TI5510-0755	TI5510-0756	TI5510-0757	TI5510-0758	TI5510-0759	
TI5510-0760	TI5510-0761	TI5510-0762	TI5510-0763	TI5510-0764	
TI5510-0770	TI5510-0771	TI5510-0772	TI5510-0773	TI5510-0774	
TI5510-0775	TI5510-0776	TI5510-0777	TI5510-0778	TI5510-0779	
TI5510-0780	TI5510-0781	TI5510-0782	TI5510-0783	TI5510-0784	



Klemmhalter | Toolholder
STGC...09
STGC...11
STGC...16

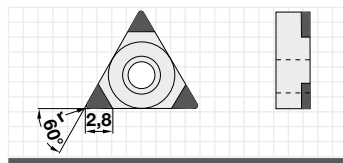

ISO-Code	H25	H45	H65	H85	H95
	DTS Code	DTS Code	DTS Code	DTS Code	DTS Code
TNGA 16 04 02	TI5010-0790	TI5010-0791	TI5010-0792	TI5010-0793	TI5010-0794
TNGA 16 04 04	TI5010-0795	TI5010-0796	TI5010-0797	TI5010-0798	TI5010-0799
TNGA 16 04 08	TI5010-0800	TI5010-0801	TI5010-0802	TI5010-0803	TI5010-0804
TNGA 16 04 12	TI5010-0805	TI5010-0806	TI5010-0807	TI5010-0808	TI5010-0809

DTS Code	P25	P45	K65	K85	S95
	DTS Code	DTS Code	DTS Code	DTS Code	DTS Code
TI5510-0790	TI5510-0791	TI5510-0792	TI5510-0793	TI5510-0794	
TI5510-0795	TI5510-0796	TI5510-0797	TI5510-0798	TI5510-0799	
TI5510-0800	TI5510-0801	TI5510-0802	TI5510-0803	TI5510-0804	
TI5510-0805	TI5510-0806	TI5510-0807	TI5510-0808	TI5510-0809	



Klemmhalter | Toolholder
 MTJNR...16
 MTENN... 16

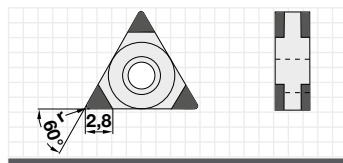

ISO-Code	H25	H45	H65	H85	H95
	DTS Code	DTS Code	DTS Code	DTS Code	DTS Code
TNGA 16 04 02	TI5010-0815	TI5010-0816	TI5010-0817	TI5010-0818	TI5010-0819
TNGA 16 04 04	TI5010-0820	TI5010-0821	TI5010-0822	TI5010-0823	TI5010-0824
TNGA 16 04 08	TI5010-0825	TI5010-0826	TI5010-0827	TI5010-0828	TI5010-0829
TNGA 16 04 12	TI5010-0830	TI5010-0831	TI5010-0832	TI5010-0833	TI5010-0834

DTS Code	P25	P45	K65	K85	S95
	DTS Code	DTS Code	DTS Code	DTS Code	DTS Code
TI5510-0815	TI5510-0816	TI5510-0817	TI5510-0818	TI5510-0819	
TI5510-0820	TI5510-0821	TI5510-0822	TI5510-0823	TI5510-0824	
TI5510-0825	TI5510-0826	TI5510-0827	TI5510-0828	TI5510-0829	
TI5510-0830	TI5510-0831	TI5510-0832	TI5510-0833	TI5510-0834	

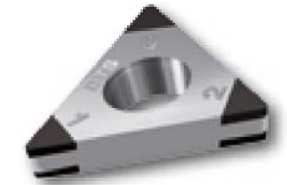

Klemmhalter | Toolholder
 MTJNR...16
 MTENN... 16

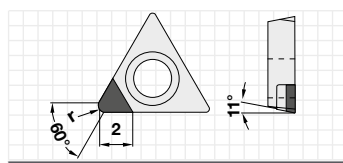

ISO-Code	H25	H45	H65	H85	H95
	DTS Code	DTS Code	DTS Code	DTS Code	DTS Code
TPGW 06 T1 01			TI5010-0786		
TPGW 06 T1 02			TI5010-0787		
TPGW 06 T1 04			TI5010-0788		

DTS Code	P25	P45	K65	K85	S95
	DTS Code	DTS Code	DTS Code	DTS Code	DTS Code



Klemmhalter | Toolholder
 E06H STXPR/L 06

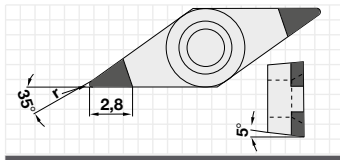

ISO-Code	H25	H45	H65	H85	H95	P25	P45	K65	K85	S95	Klemmhalter Toolholder
	beschichtet coated					unbeschichtet uncoated		unbeschichtet uncoated		unbeschichtet uncoated	
DTS Code	DTS Code	DTS Code	DTS Code	DTS Code	DTS Code	DTS Code	DTS Code	DTS Code	DTS Code	DTS Code	
VBGW 07 02 01	TI5010-1264							TI5510-1264			SVJB...07
VBGW 07 02 02	TI5010-0840	TI5010-0841	TI5010-0842	TI5010-0843	TI5010-0844	TI5510-0840	TI5510-0841	TI5510-0842	TI5510-0843	TI5510-0844	
VBGW 07 02 04	TI5010-0845	TI5010-0846	TI5010-0847	TI5010-0848	TI5010-0849	TI5510-0845	TI5510-0846	TI5510-0847	TI5510-0848	TI5510-0849	
VBGW 11 02 01	TI5010-1265							TI5510-1265			SVJB./ SVVBN..11
VBGW 11 02 02	TI5010-0855	TI5010-0856	TI5010-0857	TI5010-0858	TI5010-0859	TI5510-0855	TI5510-0856	TI5510-0857	TI5510-0858	TI5510-0859	
VBGW 11 02 04	TI5010-0860	TI5010-0861	TI5010-0862	TI5010-0863	TI5010-0864	TI5510-0860	TI5510-0861	TI5510-0862	TI5510-0863	TI5510-0864	
VBGW 11 02 08	TI5010-0865	TI5010-0866	TI5010-0867	TI5010-0868	TI5010-0869	TI5510-0865	TI5510-0866	TI5510-0867	TI5510-0868	TI5510-0869	
VBGW 16 04 01	TI5010-1267							TI5510-1267			SVJB./ SVVBN..16
VBGW 16 04 02	TI5010-0875	TI5010-0876	TI5010-0877	TI5010-0878	TI5010-0879	TI5510-0875	TI5510-0876	TI5510-0877	TI5510-0878	TI5510-0879	
VBGW 16 04 04	TI5010-0880	TI5010-0881	TI5010-0882	TI5010-0883	TI5010-0884	TI5510-0880	TI5510-0881	TI5510-0882	TI5510-0883	TI5510-0884	
VBGW 16 04 08	TI5010-0885	TI5010-0886	TI5010-0887	TI5010-0888	TI5010-0889	TI5510-0885	TI5510-0886	TI5510-0887	TI5510-0888	TI5510-0889	

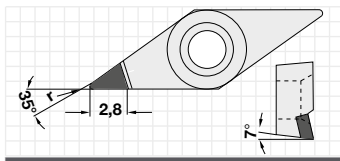

ISO-Code	H25	H45	H65	H85	H95	P25	P45	K65	K85	S95	Klemmhalter Toolholder
	beschichtet coated					unbeschichtet uncoated		unbeschichtet uncoated		unbeschichtet uncoated	
DTS Code	DTS Code	DTS Code	DTS Code	DTS Code	DTS Code	DTS Code	DTS Code	DTS Code	DTS Code	DTS Code	
VCGT 07 02 02	TI5010-0900	TI5010-0901	TI5010-0902	TI5010-0903	TI5010-0904	TI5510-0900	TI5510-0901	TI5510-0902	TI5510-0903	TI5510-0904	SVJC. / SVHC./ SVVCN...07 E10..SVQC.07
VCGT 07 02 04	TI5010-0905	TI5010-0906	TI5010-0907	TI5010-0908	TI5010-0909	TI5510-0905	TI5510-0906	TI5510-0907	TI5510-0908	TI5510-0909	
VCGT 11 03 02	TI5010-0915	TI5010-0916	TI5010-0917	TI5010-0918	TI5010-0919	TI5510-0915	TI5510-0916	TI5510-0917	TI5510-0918	TI5510-0919	SVJC. / SVHC./ SVVCN...11 E16..SVQC.11
VCGT 11 03 04	TI5010-0920	TI5010-0921	TI5010-0922	TI5010-0923	TI5010-0924	TI5510-0920	TI5510-0921	TI5510-0922	TI5510-0923	TI5510-0924	
VCGT 11 03 08	TI5010-0925	TI5010-0926	TI5010-0927	TI5010-0928	TI5010-0929	TI5510-0925	TI5510-0926	TI5510-0927	TI5510-0928	TI5510-0929	
VCGT 16 04 02	TI5010-0935	TI5010-0936	TI5010-0937	TI5010-0938	TI5010-0939	TI5510-0935	TI5510-0936	TI5510-0937	TI5510-0938	TI5510-0939	SVJC. / SVHC. / SVVCN...16 E25..SVQC.16
VCGT 16 04 04	TI5010-0940	TI5010-0941	TI5010-0942	TI5010-0943	TI5010-0944	TI5510-0940	TI5510-0941	TI5510-0942	TI5510-0943	TI5510-0944	
VCGT 16 04 08	TI5010-0945	TI5010-0946	TI5010-0947	TI5010-0948	TI5010-0949	TI5510-0945	TI5510-0946	TI5510-0947	TI5510-0948	TI5510-0949	
VCGT 16 04 12	TI5010-0950	TI5010-0951	TI5010-0952	TI5010-0953	TI5010-0954	TI5510-0950	TI5510-0951	TI5510-0952	TI5510-0953	TI5510-0954	



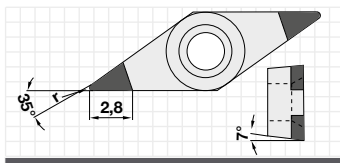

ISO-Code	beschichtet coated					unbeschichtet uncoated					Klemmhalter Toolholder
	H25	H45	H65	H85	H95	P25	P45	K65	K85	S95	
VCGW 05 01 01 [CL 2,0]			TI5010-1561								E... SVLC. 05
VCGW 05 01 02 [CL 2,0]			TI5010-1562								
VCGW 05 01 04 [CL 2,0]			TI5010-1563								
VCGW 07 02 01	TI5010-1274							TI5510-1274			SVJC. / SVHC. / SVVCN...07 E10..SVQC.07
VCGW 07 02 02	TI5010-0960	TI5010-0961	TI5010-0962	TI5010-0963	TI5010-0964	TI5510-0960	TI5510-0961	TI5510-0962	TI5510-0963	TI5510-0964	
VCGW 07 02 04	TI5010-0965	TI5010-0966	TI5010-0967	TI5010-0968	TI5010-0969	TI5510-0965	TI5510-0966	TI5510-0967	TI5510-0968	TI5510-0969	
VCGW 11 03 01	TI5010-1275							TI5510-1275			SVJC. / SVHC. / SVVCN...11 E16..SVQC.11
VCGW 11 03 02	TI5010-0975	TI5010-0976	TI5010-0977	TI5010-0978	TI5010-0979	TI5510-0975	TI5510-0976	TI5510-0977	TI5510-0978	TI5510-0979	
VCGW 11 03 04	TI5010-0980	TI5010-0981	TI5010-0982	TI5010-0983	TI5010-0984	TI5510-0980	TI5510-0981	TI5510-0982	TI5510-0983	TI5510-0984	
VCGW 11 03 08	TI5010-0985	TI5010-0986	TI5010-0987	TI5010-0988	TI5010-0989	TI5510-0985	TI5510-0986	TI5510-0987	TI5510-0988	TI5510-0989	
VCGW 16 04 01	TI5010-1277							TI5510-1277			SVJC. / SVHC. / SVVCN...16 E25..SVQC.16
VCGW 16 04 02	TI5010-0995	TI5010-0996	TI5010-0997	TI5010-0998	TI5010-0999	TI5510-0995	TI5510-0996	TI5510-0997	TI5510-0998	TI5510-0999	
VCGW 16 04 04	TI5010-1000	TI5010-1001	TI5010-1002	TI5010-1003	TI5010-1004	TI5510-1000	TI5510-1001	TI5510-1002	TI5510-1003	TI5510-1004	
VCGW 16 04 08	TI5010-1005	TI5010-1006	TI5010-1007	TI5010-1008	TI5010-1009	TI5510-1005	TI5510-1006	TI5510-1007	TI5510-1008	TI5510-1009	
VCGW 16 04 12	TI5010-1010	TI5010-1011	TI5010-1012	TI5010-1013	TI5010-1014	TI5510-1010	TI5510-1011	TI5510-1012	TI5510-1013	TI5510-1014	

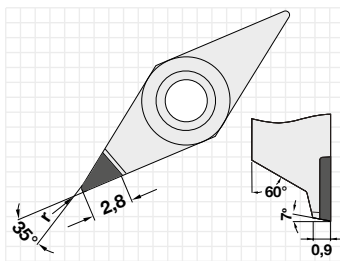

ISO-Code	unbeschichtet uncoated					unbeschichtet uncoated			Klemmhalter Toolholder
	H25	H45	H65	H85	H95	P25	P45	K65	
VXGW 16 04 01								TI5510-1650	SVJX.. / SVVXN.. 16
VXGW 16 04 02								TI5510-1655	
VXGW 16 04 04								TI5510-1660	

Weitere Sonderwerkzeuge gerne auf Anfrage
Special tools on request
info@diamond-toolingsystems.com

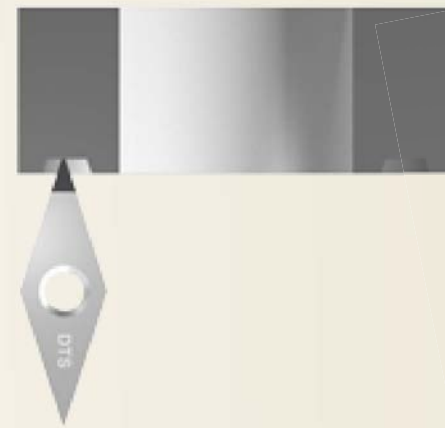

Spezialausführung
Special Type

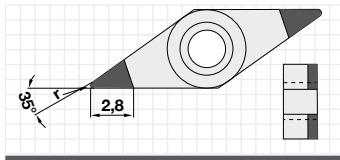

ISO-Code	DTS Code	DTS Code	DTS Code	DTS Code	DTS Code
VNGA 16 04 02	TI5010-1020	TI5010-1021	TI5010-1022	TI5010-1023	TI5010-1024
VNGA 16 04 04	TI5010-1025	TI5010-1026	TI5010-1027	TI5010-1028	TI5010-1029
VNGA 16 04 08	TI5010-1030	TI5010-1031	TI5010-1032	TI5010-1033	TI5010-1034
VNGA 16 04 12	TI5010-1035	TI5010-1036	TI5010-1037	TI5010-1038	TI5010-1039

DTS Code	DTS Code	DTS Code	DTS Code	DTS Code
TI5510-1020	TI5510-1021	TI5510-1022	TI5510-1023	TI5510-1024
TI5510-1025	TI5510-1026	TI5510-1027	TI5510-1028	TI5510-1029
TI5510-1030	TI5510-1031	TI5510-1032	TI5510-1033	TI5510-1034
TI5510-1035	TI5510-1036	TI5510-1037	TI5510-1038	TI5510-1039



Klemmhalter | Toolholder
MVJN./MVVNN...16

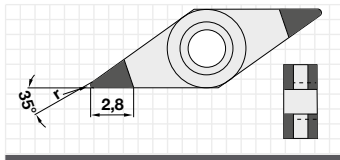

ISO-Code	DTS Code	DTS Code	DTS Code	DTS Code	DTS Code
VNGA 16 04 02	TI5010-1045	TI5010-1046	TI5010-1047	TI5010-1048	TI5010-1049
VNGA 16 04 04	TI5010-1050	TI5010-1051	TI5010-1052	TI5010-1053	TI5010-1054
VNGA 16 04 08	TI5010-1055	TI5010-1056	TI5010-1057	TI5010-1058	TI5010-1059
VNGA 16 04 12	TI5010-1060	TI5010-1061	TI5010-1062	TI5010-1063	TI5010-1064

DTS Code	DTS Code	DTS Code	DTS Code	DTS Code
TI5510-1045	TI5510-1046	TI5510-1047	TI5510-1048	TI5510-1049
TI5510-1050	TI5510-1051	TI5510-1052	TI5510-1053	TI5510-1054
TI5510-1055	TI5510-1056	TI5510-1057	TI5510-1058	TI5510-1059
TI5510-1060	TI5510-1061	TI5510-1062	TI5510-1063	TI5510-1064



Klemmhalter | Toolholder
MVJN./MVVNN...16

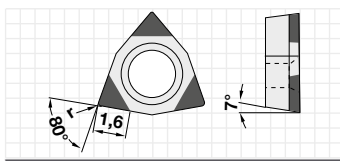

ISO-Code	DTS Code	DTS Code	DTS Code	DTS Code	DTS Code
WCGW 02 01 01			TI5010-1571		
WCGW 02 01 02			TI5010-1572		
WCGW 02 01 04			TI5010-1573		

DTS Code	DTS Code	DTS Code	DTS Code	DTS Code



Klemmhalter | Toolholder
E... SWUC. 02

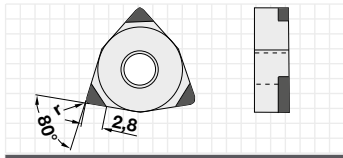

		H25	H45	H65	H85	H95									
		beschichtet coated					P25	P45	K65	K85	S95				
ISO-Code		DTS Code	DTS Code	DTS Code	DTS Code	DTS Code	DTS Code	DTS Code	DTS Code	DTS Code	DTS Code	DTS Code	DTS Code	Klemmhalter Toolholder	
Standard	WNGA 08 04 02	TI5010-1070	TI5010-1071	TI5010-1072	TI5010-1073	TI5010-1074	TI5510-1070	TI5510-1071	TI5510-1072	TI5510-1073	TI5510-1074	DWLN./ MWLN...08			
	WNGA 08 04 04	TI5010-1075	TI5010-1076	TI5010-1077	TI5010-1078	TI5010-1079	TI5510-1075	TI5510-1076	TI5510-1077	TI5510-1078	TI5510-1079				
	WNGA 08 04 08	TI5010-1080	TI5010-1081	TI5010-1082	TI5010-1083	TI5010-1084	TI5510-1080	TI5510-1081	TI5510-1082	TI5510-1083	TI5510-1084				
	WNGA 08 04 12	TI5010-1085	TI5010-1086	TI5010-1087	TI5010-1088	TI5010-1089	TI5510-1085	TI5510-1086	TI5510-1087	TI5510-1088	TI5510-1089				
Wiper	WNGA 08 04 04	TI5010-1095	TI5010-1096	TI5010-1097	TI5010-1098	TI5010-1099	TI5510-1095	TI5510-1096	TI5510-1097	TI5510-1098	TI5510-1099	DWLN./ MWLN...08			
	WNGA 08 04 08	TI5010-1100	TI5010-1101	TI5010-1102	TI5010-1103	TI5010-1104	TI5510-1100	TI5510-1101	TI5510-1102	TI5510-1103	TI5510-1104				
	WNGA 08 04 12	TI5010-1105	TI5010-1106	TI5010-1107	TI5010-1108	TI5010-1109	TI5510-1105	TI5510-1106	TI5510-1107	TI5510-1108	TI5510-1109				

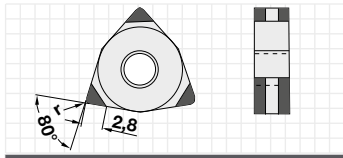

		H25	H45	H65	H85	H95									
		beschichtet coated					P25	P45	K65	K85	S95				
ISO-Code		DTS Code	DTS Code	DTS Code	DTS Code	DTS Code	DTS Code	DTS Code	DTS Code	DTS Code	DTS Code	DTS Code	DTS Code	Klemmhalter Toolholder	
Standard	WNGA 08 04 02	TI5010-1115	TI5010-1116	TI5010-1117	TI5010-1118	TI5010-1119	TI5510-1115	TI5510-1116	TI5510-1117	TI5510-1118	TI5510-1119	DWLN./ MWLN...08			
	WNGA 08 04 04	TI5010-1120	TI5010-1121	TI5010-1122	TI5010-1123	TI5010-1124	TI5510-1120	TI5510-1121	TI5510-1122	TI5510-1123	TI5510-1124				
	WNGA 08 04 08	TI5010-1125	TI5010-1126	TI5010-1127	TI5010-1128	TI5010-1129	TI5510-1125	TI5510-1126	TI5510-1127	TI5510-1128	TI5510-1129				
	WNGA 08 04 12	TI5010-1130	TI5010-1131	TI5010-1132	TI5010-1133	TI5010-1134	TI5510-1130	TI5510-1131	TI5510-1132	TI5510-1133	TI5510-1134				
Wiper	WNGA 08 04 04	TI5010-1140	TI5010-1141	TI5010-1142	TI5010-1143	TI5010-1144	TI5510-1140	TI5510-1141	TI5510-1142	TI5510-1143	TI5510-1144	DWLN./ MWLN...08			
	WNGA 08 04 08	TI5010-1145	TI5010-1146	TI5010-1147	TI5010-1148	TI5010-1149	TI5510-1145	TI5510-1146	TI5510-1147	TI5510-1148	TI5510-1149				
	WNGA 08 04 12	TI5010-1150	TI5010-1151	TI5010-1152	TI5010-1153	TI5010-1154	TI5510-1150	TI5510-1151	TI5510-1152	TI5510-1153	TI5510-1154				

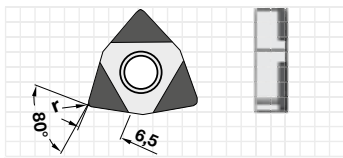

		H25	H45	H65	H85	H95									
		beschichtet coated					P25	P45	K65	K85	S95				
ISO-Code		DTS Code	DTS Code	DTS Code	DTS Code	DTS Code	DTS Code	DTS Code	DTS Code	DTS Code	DTS Code	DTS Code	DTS Code	Klemmhalter Toolholder	
	WNGA 08 04 04									TI5510-1291			DWLN./ MWLN...08		
	WNGA 08 04 08									TI5510-1292					
	WNGA 08 04 12									TI5510-1293					



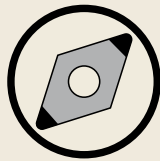

PASSION FOR DIAMOND



Diamond Tooling Systems

DTS GmbH - Deutschland

Hans-Geiger Straße 11a · D-67661 Kaiserslautern

office: +49 (0) 6301 32011-0

fax: +49 (0) 6301 32011-90

mail: info@diamond-toolingsystems.com

www.diamond-toolingsystems.com